

REV.	DESCRIPTION	DATE
A	RELEASE	July 26, 2018
B	21,0811	Aug 15, 2021

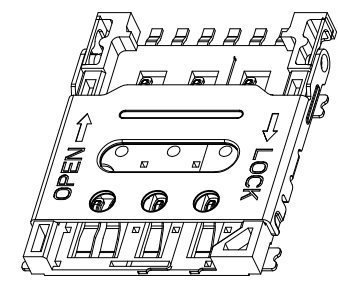

NOTES:

- 1) 材质:
 主体: LCP UL 94V-0
 端子: C5210-EH, T=0.15
 壳子: SUS304-3/4H, T=0.20
- 2) 电镀:
 端子: 整体镀镍底30u"-50u", 触点刷金1u", 焊脚刷金1u"
 外壳: 整体表面洗油即可。

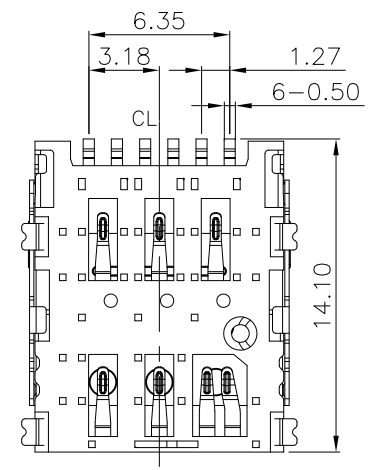
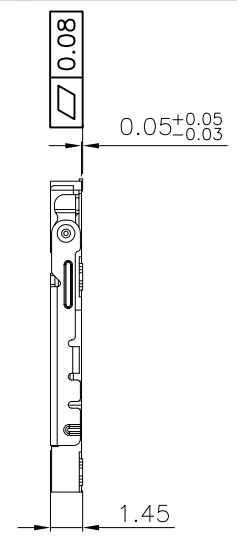
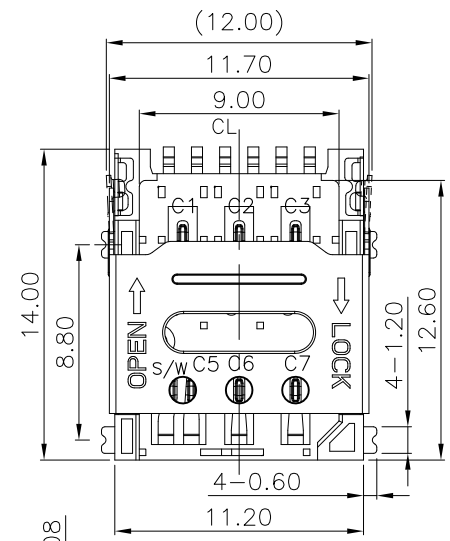
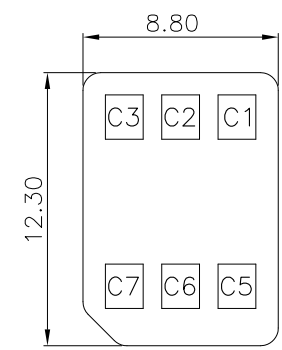
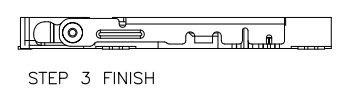
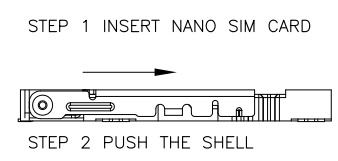
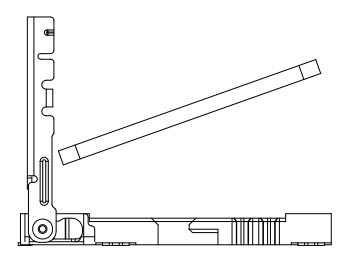
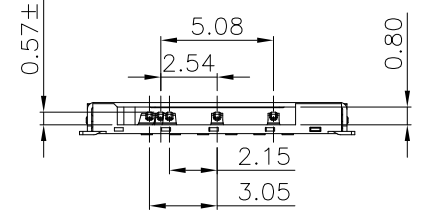

PART NUMBER INFORMATION :

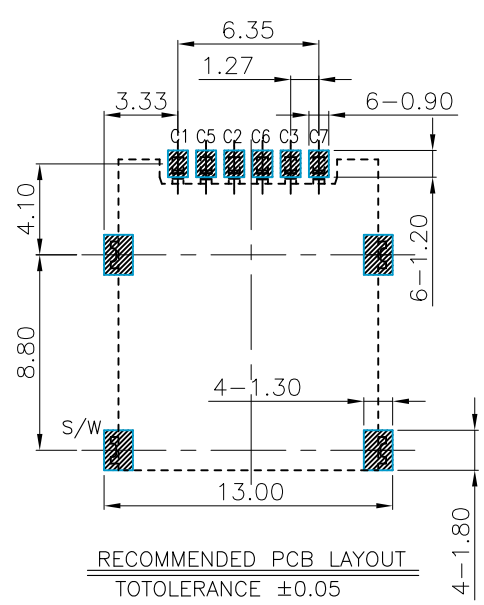
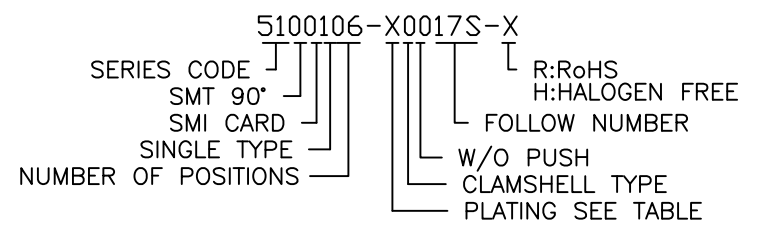

PIN NO.	PIN NAME
C1	VCC
C2	RST
C3	CLK
C5	GND
C6	VPP
C7	I/O
S/W	Switch Pin

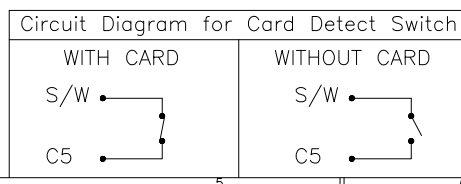

TOLERANCE		DRAWER	
.0=±0.30		31	
.00=±0.25		CHECK	
.000=±0.05		31	
ANG.=±3°		APP'D	
UNITS : mm		31	
SCALE NONE		PRODUCT SPEC.	
SIZE A7		DRAW NO.	
SHEET 2 OF 3		REV. A	

INMO

东莞市英墨电子有限公司
INMO Electronics Co.,Ltd

NAME: NANO SIM 7PIN 1.45H
带侦测PIN 掀盖式 卡座

DRAW NO.: R5100106-X0017S-X

REV.	DESCRIPTION	DATE
A	RELEASE	July 26, 2018

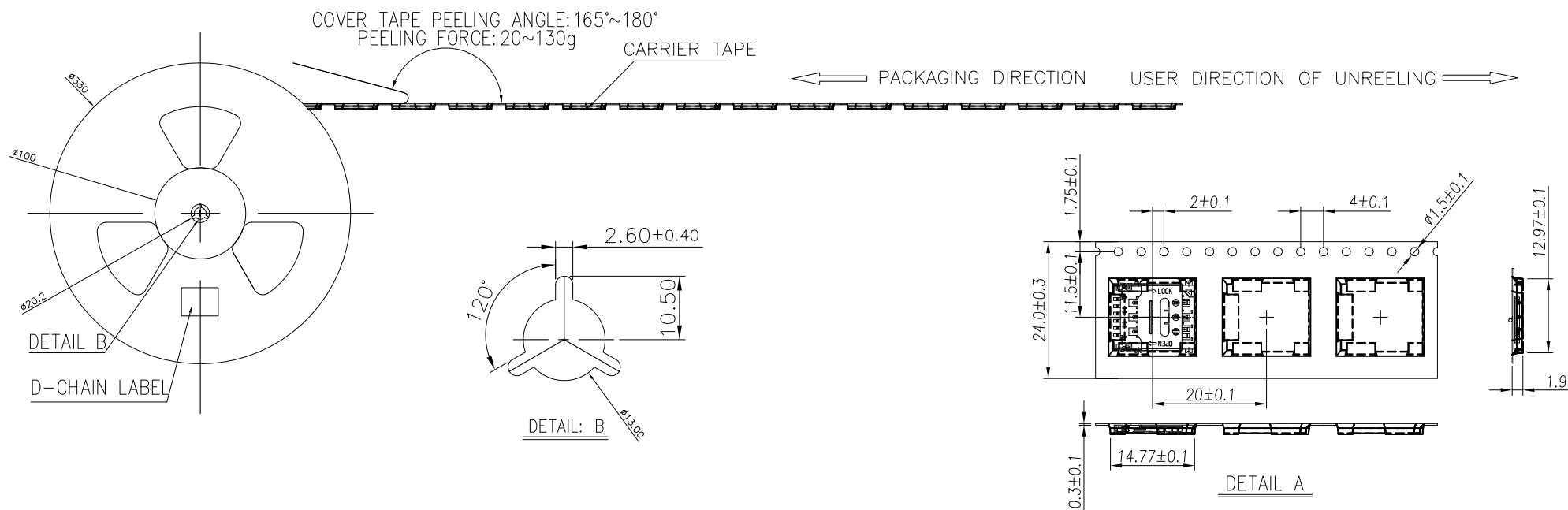
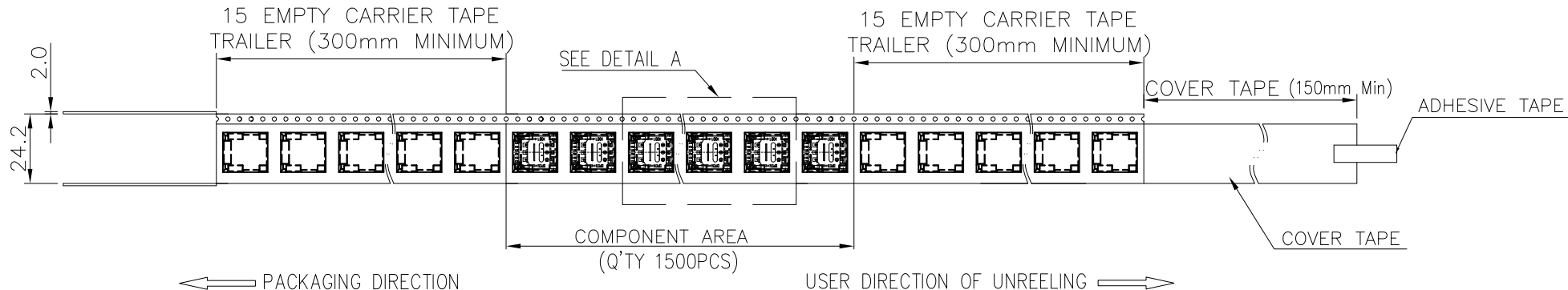

1		1500	11	XX	16500	350X350X350
ITEM	PRODUCT No.	Q'TY/REEL	REEL/CARTON	Kg/CARTON	Q'TY/CARTON	CARTON SIZE

TOLERANCE .0±±0.25 .00±±0.15 .000±±0.05 ANG.=±3°		DRAWER ZU CHECK ZU APP'D ZUWX		INMO 东莞市英墨电子有限公司 INMO Electronics Co.,Ltd	
 UNITS : mm		PRODUCT SPEC. —		NAME NANO SIM 7PIN 1.45H 翻盖式 包装图	
SCALE NONE	SIZE A7	SHEET 3 OF 3	REV. A	DRAW NO. R5100106-X017S-X	